

NWE Wall Sconce

Elbow

Lamp: 60W Candelabra
 40W G9 Halogen
 50W 12V Bi-Pin GY6.35

PRODUCT DESCRIPTION

Surface mount steel canopy with soft elbow curve. Mounts directly to the junction box and includes a universal mounting ring. A variety of unique glass colors and shapes allow each application a distinctive personality. A sconce can compliment pendant fixtures mounted on track or rail. Order glass and lamp separately (NWE-19 includes lamp).

Features

- Universal mounting ring.
- Accommodates hundreds of glass shades in a variety of styles, colors, and textures.
- Variety of lamps sources.
- Line or low voltage.
- Mounted upward or downward position.
- Electronic transformer included (low voltage).

Dimming

Line Voltage may be dimmed with a standard incandescent dimmer.
 Low Voltage requires a low voltage electronic dimmer.

Transformer (NWE-46 only)

60W Electronic transformer is included for mounting in the junction box.

Socket (Check Glass Selection for Compatibility)

NWE-12 - E12 candelabra socket rated for 60W 120V lamp max.
 NWE-19 - Porcelain G9 socket rated for 40W 120V lamp max.
 NWE-46 - Porcelain GY6.35 socket rated for 50W 12V lamp max.

Lamp

NWE-12 - 60W Candelabra max. (not included)
 NWE-19 - 40W G9 Halogen max. (included)
 NWE-46 - 50W JC Bi-Pin GY6.35 max. (not included)

Lamp Shield

Protected frosted lamp shield included for NWE-19 and NWE-46.

Finishes

Brushed Nickel (plated), Bronze and Silver (powder coated).

Labels and Listings

UL and cUL Listed



NORALIGHTING®

Type _____

Project _____

Catalog No. _____

Lamp/Wattage _____

DIMENSIONS

Dimensions

Canopy Diameter: 4.49" (114mm)
 Canopy Width: .87" (22mm)
 Maximum Height: 5.56" (143mm)
 Maximum Width: 4.23" (110mm)

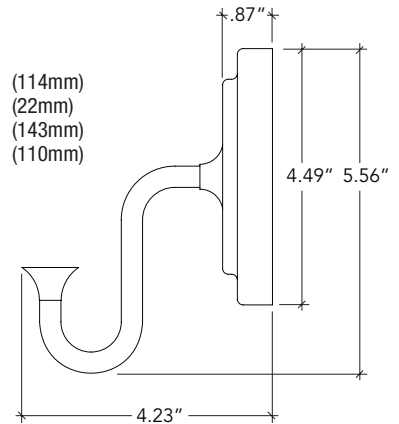

PRODUCT IMAGE: NWS-46BZ



Create a complete fixture/glass catalog number: Example: NWE-46BZ / NRS80-480BR

Wall Sconce - select one box from each column

Catalog No.	Lamp	Finish
NWE	12 = Candelabra	BN
	19 = G9 Halogen	BZ
	46 = JC GY6.35	S

Finishes: BN = Brushed Nickel, BZ = Bronze, S = Silver

Glass - select Catalog No. and Finish (Refer to Compatible Glass Pages for available glass finishes)

Catalog No.	Finish
NG-50 NRS80-463 NRS82-202	AM MG
NG-66 NRS80-465 NRS82-203	AQ O
NG-70 NRS80-466 NRS82-204	AY P
NG-90 NRS80-470	BE R
NRS80-204 NRS80-471	BR RF
NRS80-401 NRS80-474	BU S
NRS80-406 NRS80-475	BZ W
NRS80-408 NRS80-476	CL
NRS80-456 NRS80-480	FR
NRS80-458 NRS80-484	G
NRS80-459 NRS80-490	GBR
NRS80-462 NRS82-201	GR

Finishes:

AM = Amber, AQ = Aqua, AY = Amethyst, BE = Beige, BR = Brown, BU = Blue, BZ = Bronze, CL = Clear, FR = Frost, G = Gold, GBR = Granite Brown, GR = Green, MG = Magna, O = Orange, P = Purple, R = Red, RF = Red Fire, S = Silver, W = White

NWE Compatible Glass

NG-50 Conical

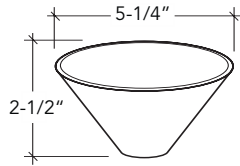

Glass Finish: Amber (A), Blue (B), Green (G), White (W)
 Lamp: 40W G9 Halogen, 50W JC GY6.35 Bi-Pin
 Glass Diameter: 5-1/4"
 Glass Height: 2-1/2"

NRS80-204 Swift

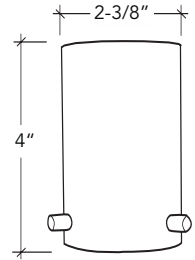

Glass Finishes: Amber (AM), Frost (FR), Orange (O)
 Lamp: 40W G9 Halogen, 50W JC GY6.35 Bi-Pin
 Glass Diameter: 2-3/8"
 Glass Height: 4"

NG-66 Fluted

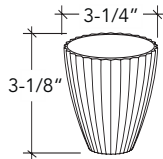

Glass Finishes: Amber (A), Blue (B), Green (G), White (W)
 Lamp: 40W G9 Halogen, 50W JC GY6.35 Bi-Pin
 Glass Diameter: 3-1/4"
 Glass Height: 3-1/8"

NRS80-401 Ice Cube

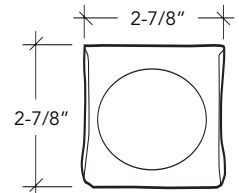

Glass Finishes: Amber (AM), Aqua (AQ), Amethyst (AY), Blue (BU), Clear (CL)
 Lamp: 40W G9 Halogen, 50W JC GY6.35 Bi-Pin
 Glass Height: 2-7/8"
 Glass Length: 2-7/8"

NG-70 Split Cone

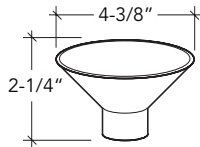

Glass Finishes: Amber (A), Blue (B), Green (G), White (W)
 Lamp: 40W G9 Halogen, 50W JC GY6.35 Bi-Pin
 Glass Diameter: 4-3/8"
 Glass Height: 2-1/4"

NRS80-406 Silk

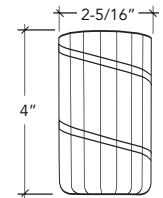

Glass Finishes: Dichroic
 Lamp: 40W G9 Halogen, 50W JC GY6.35 Bi-Pin
 Glass Diameter: 2-5/16"
 Glass Height: 4"

NG-90 Stepped Round

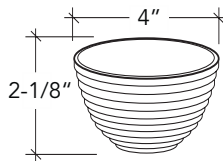

Glass Finishes: Amber (A), Blue (B), Green (G), White (W)
 Lamp: 40W G9 Halogen, 50W JC GY6.35 Bi-Pin
 Glass Diameter: 4"
 Glass Height: 2-1/8"

NRS80-408 Sheer

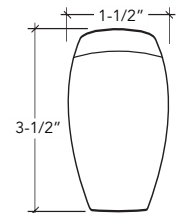

Glass Finishes: Dichroic
 Lamp: 40W G9 Halogen, 50W JC GY6.35 Bi-Pin
 Glass Diameter: 1-1/2"
 Glass Height: 3-1/2"

NWE Compatible Glass

NRS80-456 Mercure

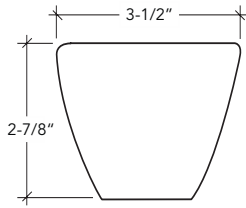

Glass Finishes: Blue (BU), Clear (CL), Orange (O)
 Lamp: 40W G9 Halogen, 50W JC GY6.35 Bi-Pin
 Glass Diameter: 3-1/2"
 Glass Height: 2-7/8"

NRS80-463 Reflections

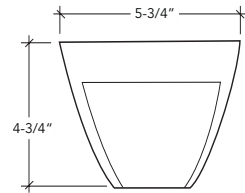

Glass Finish: Mirror
 Lamp: 40W G9 Halogen, 50W JC GY6.35 Bi-Pin
 Glass Diameter: 5-3/4"
 Glass Height: 4-3/4"

NRS80-458 Roba-M

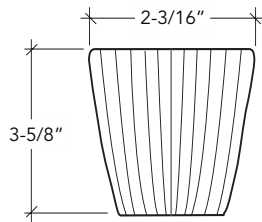

Glass Finishes: Blue (BU), Frost (FR)
 Lamp: 40W G9 Halogen, 50W JC GY6.35 Bi-Pin
 Glass Diameter: 2-3/16"
 Glass Height: 3-5/8"

NRS80-465 Tanner

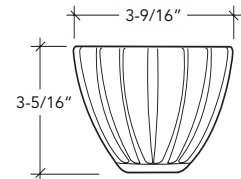

Glass Finishes: Gold (G), Silver (S)
 Lamp: 40W G9 Halogen, 50W JC GY6.35 Bi-Pin
 Glass Diameter: 3-9/16"
 Glass Height: 3-5/16"

NRS80-459 Roba-L

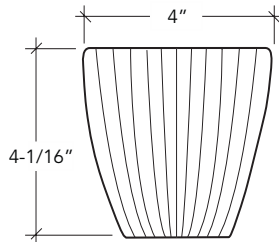

Glass Finishes: Blue (BU), Frost (FR)
 Lamp: 40W G9 Halogen, 50W JC GY6.35 Bi-Pin
 Glass Diameter: 4"
 Glass Height: 4-1/16"

NRS80-466 Elvin

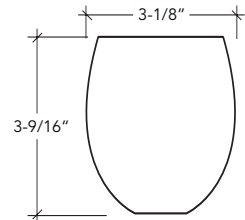

Glass Finishes: Amber (AM), Blue (BU), Red (R), White (W)
 Lamp: 40W G9 Halogen, 50W JC GY6.35 Bi-Pin
 Glass Diameter: 3-1/8"
 Glass Height: 3-9/16"

NRS80-462 Casie

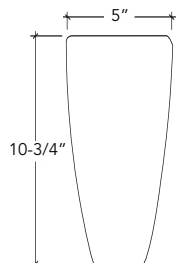

Glass Finishes: Blue (BU), Orange (O), Purple (P), White (W)
 Lamp: 60W E12 Candelabra, 40W G9 Halogen, 50W JC GY6.35 Bi-Pin
 Glass Diameter: 5"
 Glass Height: 10-3/4"

NRS80-470 Feather

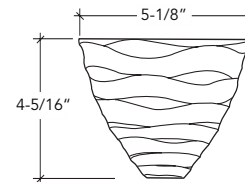

Glass Finish: White on White
 Lamp: 60W E12 Candelabra, 40W G9 Halogen, 50W JC GY6.35 Bi-Pin
 Glass Diameter: 5-1/8"
 Glass Height: 4-5/16"

NWE Compatible Glass

NRS80-471 Ferus

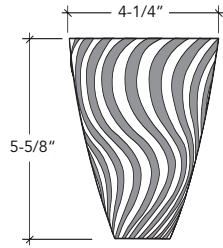

Glass Finish: Black on White
 Lamp: 60W E12 Candelabra, 40W G9 Halogen, 50W JC GY6.35 Bi-Pin
 Glass Diameter: 4-1/4"
 Glass Height: 5-5/8"

NRS80-480 Rain

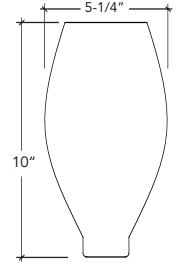

Glass Finishes: Brown (BR), Blue (BU), Green (GR), Red (R), White (W)
 Lamp: 60W E12 Candelabra, 40W G9 Halogen, 50W JC GY6.35 Bi-Pin
 Glass Diameter: 5-1/4"
 Glass Height: 10"

NRS80-474 Eric

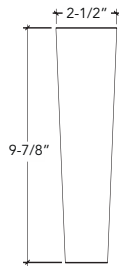

Glass Finishes: Amber (AM), White (W)
 Lamp: 60W E12 Candelabra, 40W G9 Halogen, 50W JC GY6.35 Bi-Pin
 Glass Diameter: 2-1/2"
 Glass Height: 9-7/8"

NRS80-484 River

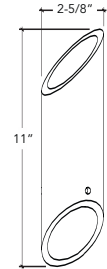

Glass Finishes: Beige (BE), Blue (BU), Granite Brown (GBR), Red Fire (RF), White (W)
 Lamp: 60W E12 Candelabra, 40W G9 Halogen, 50W JC GY6.35 Bi-Pin
 Glass Diameter: 2-5/8"
 Glass Height: 11"

NRS80-475 Bonita Cone

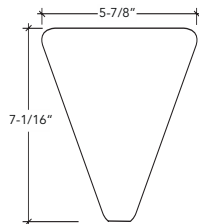
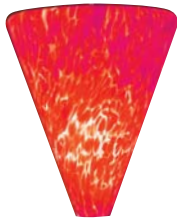

Glass Finishes: Amber (AM), Magna (MG), Red (R), White (W)
 Lamp: 60W E12 Candelabra, 40W G9 Halogen, 50W JC GY6.35 Bi-Pin
 Glass Diameter: 5-7/8"
 Glass Height: 7-1/16"

NRS80-490 Trumpet

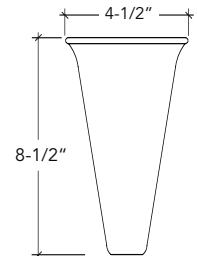

Glass Finishes: Amber (AM), Blue (BU), Red (R), White (W)
 Lamp: 60W E12 Candelabra, 40W G9 Halogen, 50W JC GY6.35 Bi-Pin
 Glass Diameter: 4-1/2"
 Glass Height: 8-1/2"

NRS80-476 Grant

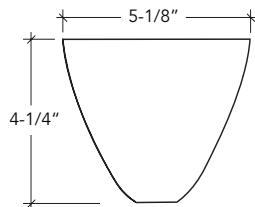

Glass Finishes: Amber (AM), Blue (BU), Bronze (BZ), Green (GR), Red (R)
 Lamp: 60W E12 Candelabra, 40W G9 Halogen, 50W JC GY6.35 Bi-Pin
 Glass Diameter: 5-1/8"
 Glass Height: 4-1/4"

NRS82-201 Paris

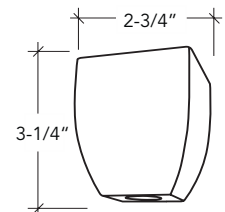

Glass Finishes: Amber (AM), Brown (BR), Blue (BU), Red (R), White (W)
 Lamp: 40W G9 Halogen, 50W JC GY6.35 Bi-Pin
 Glass Diameter: 2-3/4"
 Glass Height: 3-1/4"

NWE Compatible Glass

NRS82-202 Monte

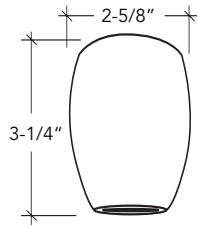

Glass Finishes: Amber (AM), Brown (BR), Blue (BU), Red (R), White (W)
Lamp: 40W G9 Halogen, 50W JC GY6.35 Bi-Pin
Glass Diameter: 2-5/8"
Glass Height: 3-1/4"

NRS82-203 Chicago

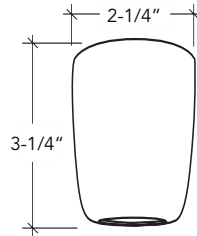

Glass Finishes: Amber (AM), Brown (BR), Blue (BU), Red (R), White (W)
Lamp: 40W G9 Halogen, 50W JC GY6.35 Bi-Pin
Glass Diameter: 2-1/4"
Glass Height: 3-1/4"

NRS82-204 Madeleine

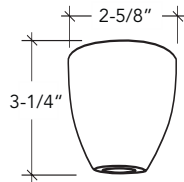

Glass Finishes: Amber (AM), Brown (BR), Blue (BU), Red (R), White (W)
Lamp: 40W G9 Halogen, 50W JC GY6.35 Bi-Pin
Glass Diameter: 2-5/8"
Glass Height: 3-1/4"